

# CONSTRUCTION METAL PRODUCTS INC.

Metal Roofing | Metal Walls | Custom Fabrication

## SYSTEM: CMP SERIES 1500 DRAWINGS



**CMP**

Statesville, NC | Myrtle Beach, SC | Charleston, SC  
704-871-8704 | [questions@cmpmetalsystems.com](mailto:questions@cmpmetalsystems.com)  
[www.cmpmetalsystems.com](http://www.cmpmetalsystems.com)



# CONTENTS

- **PANEL & CLIP PROFILE ..... 3**
- **PANEL SEALANT ..... 4**
- **EAVE FLASHING WITH GUTTER ..... 5**
- **LOCKING EAVE ..... 6**
- **HIGH EAVE ..... 7**
- **GABLE END ..... 8**
- **HIP/RIDGE ..... 9**
- **VENTED RIDGE ..... 10**
- **VALLEY ..... 11**
- **ROOF TO WALL ..... 12**
- **PITCHBREAK FLASHING ..... 13**



## PANEL & CLIP PROFILE

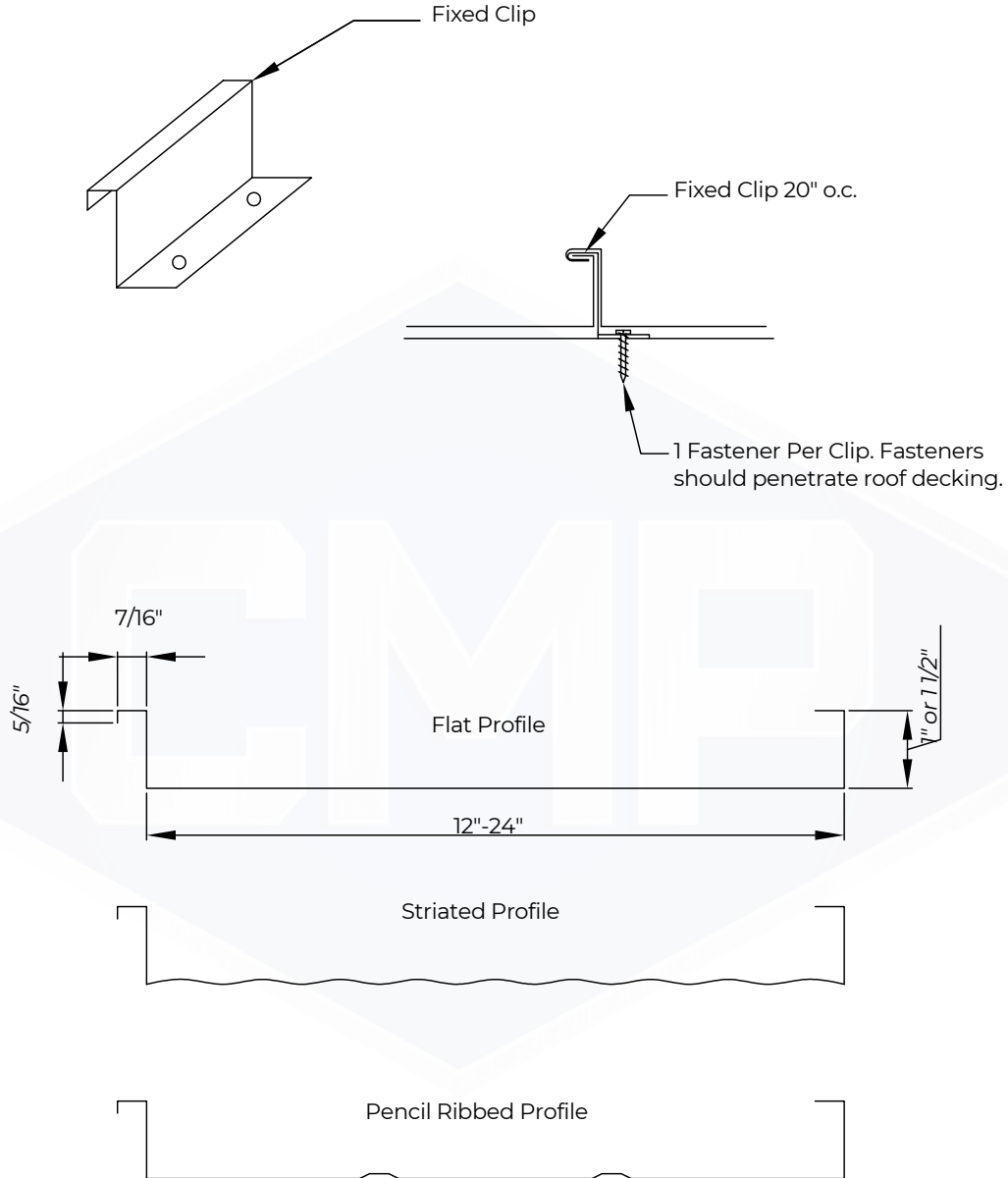

Note: Striated Profile is Standard

<b>DETAIL: PANEL &amp; CLIP PROFILE</b>	<b>CMP</b>	<b>SCALE:</b>
<b>SYSTEM: CMP SERIES 1500</b>		<b>DRAWING NO: 1</b>



## PANEL SEALANT

Field notch & hem  
under eave flashing.

Apply tube sealant  
for first 10" of panel

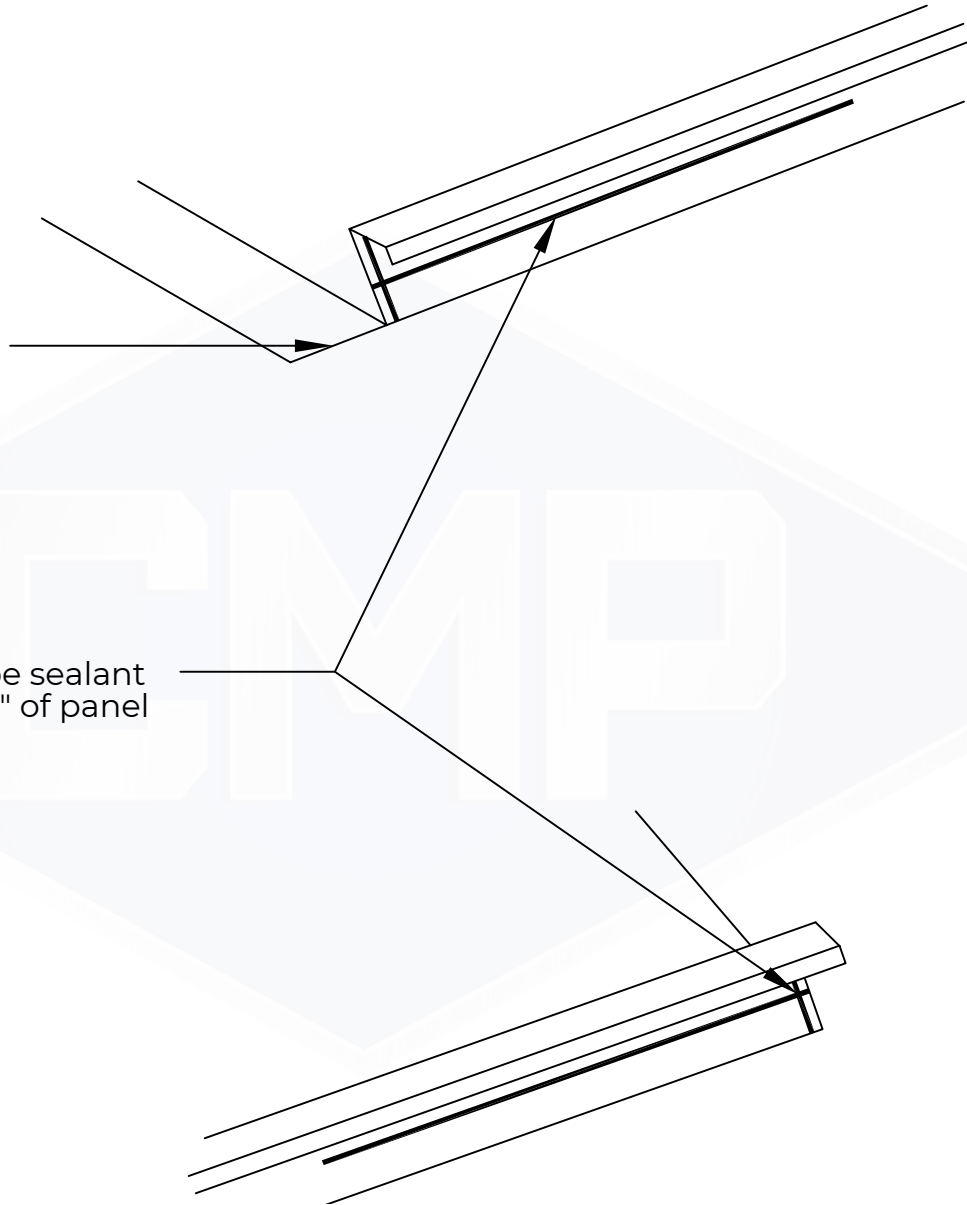

<b>DETAIL: PANEL SEALANT</b>	<b>CMP</b>	<b>SCALE:</b>
<b>SYSTEM: CMP SERIES 1500</b>		<b>DRAWING NO: 2</b>



# EAVE FLASHING WITH GUTTER

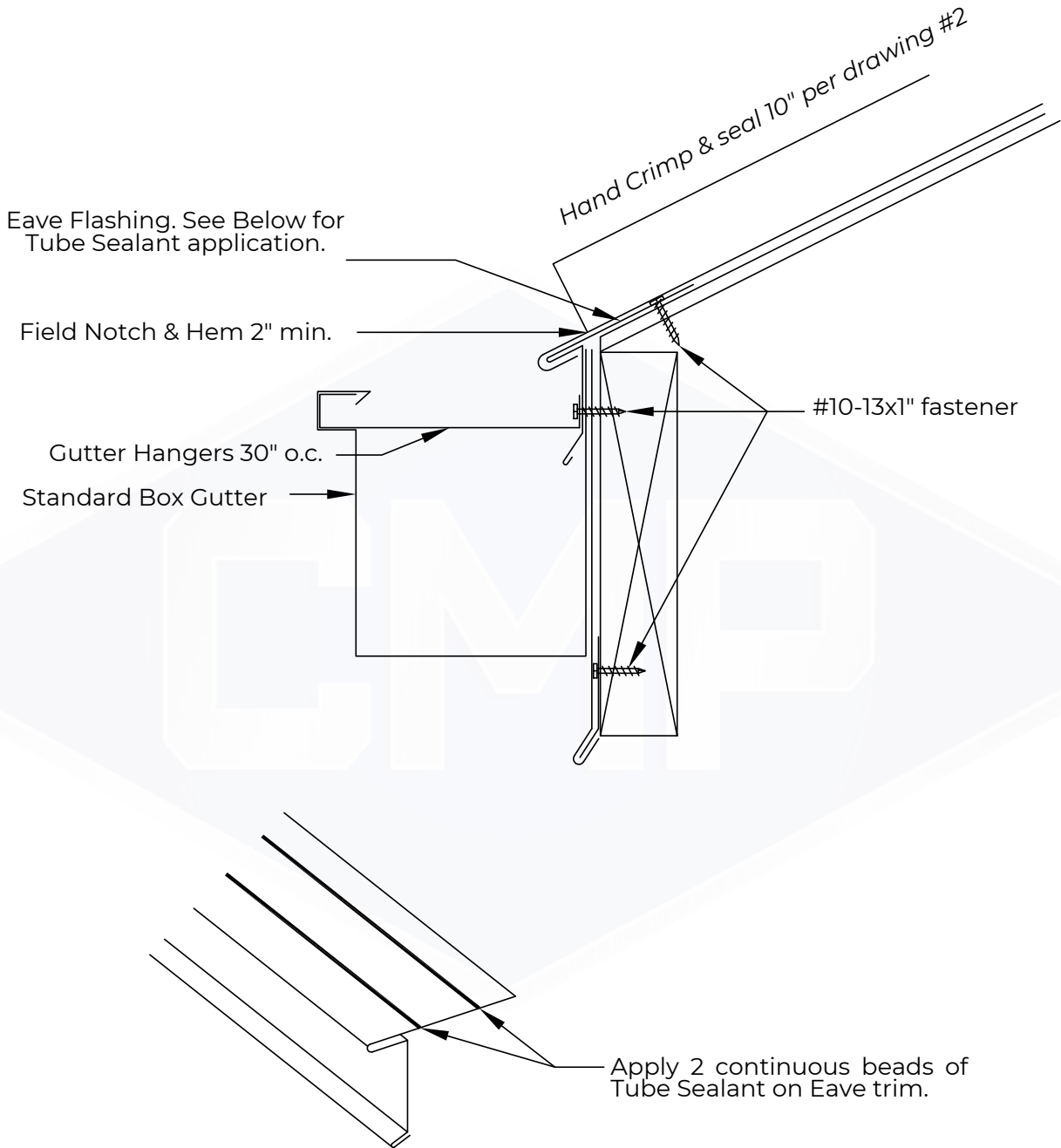

<b>DETAIL: EAVE FLASHING WITH GUTTER</b>	<b>CMP</b>	<b>SCALE:</b>
<b>SYSTEM: CMP SERIES 1500</b>		<b>DRAWING NO: 3</b>

## LOCKING EAVE

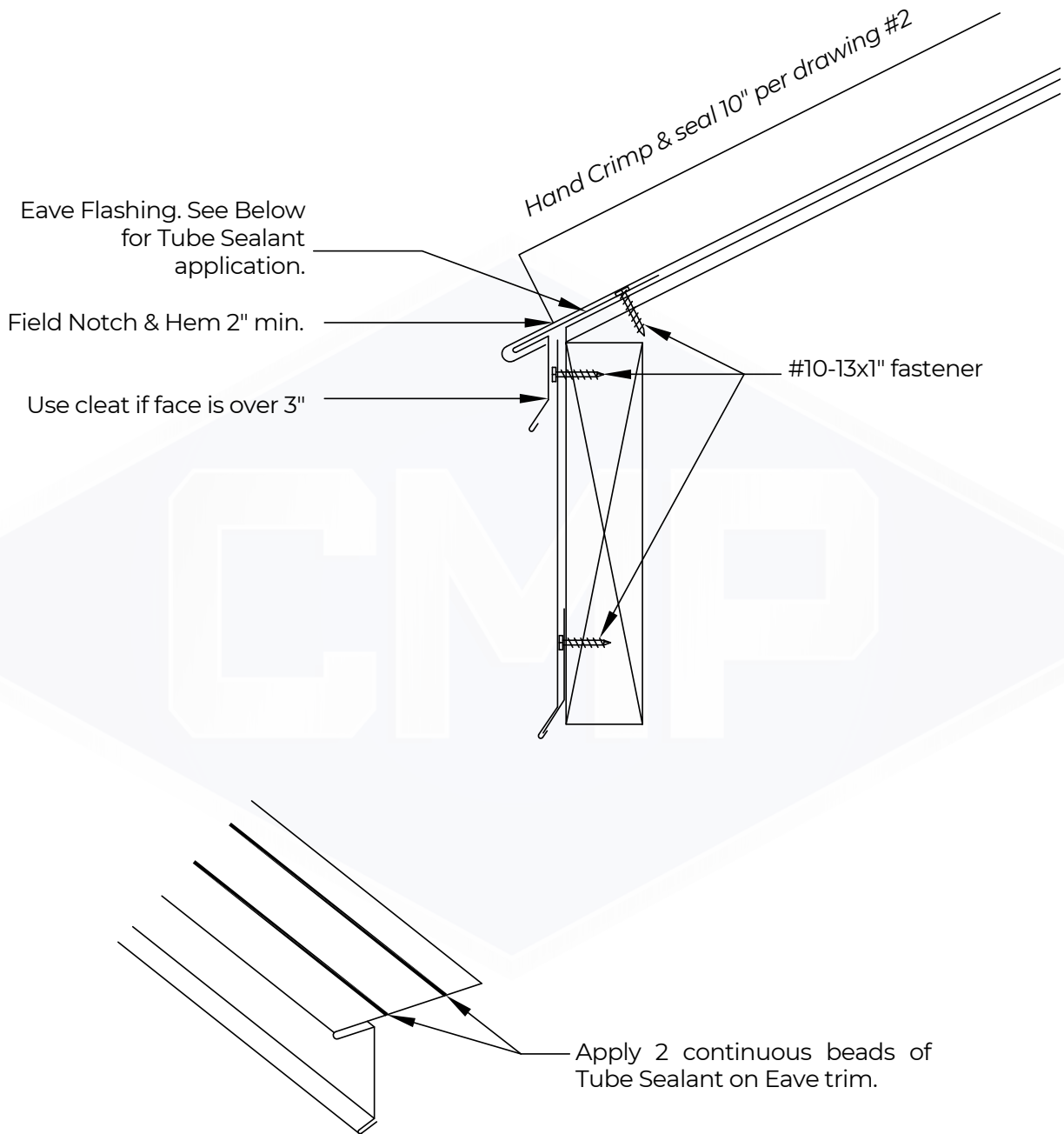

<b>DETAIL: LOCKING EAVE</b>	<b>CMP</b>	<b>SCALE:</b>
<b>SYSTEM: CMP SERIES 1500</b>		<b>DRAWING NO: 4</b>



## HIGH EAVE FLASHING

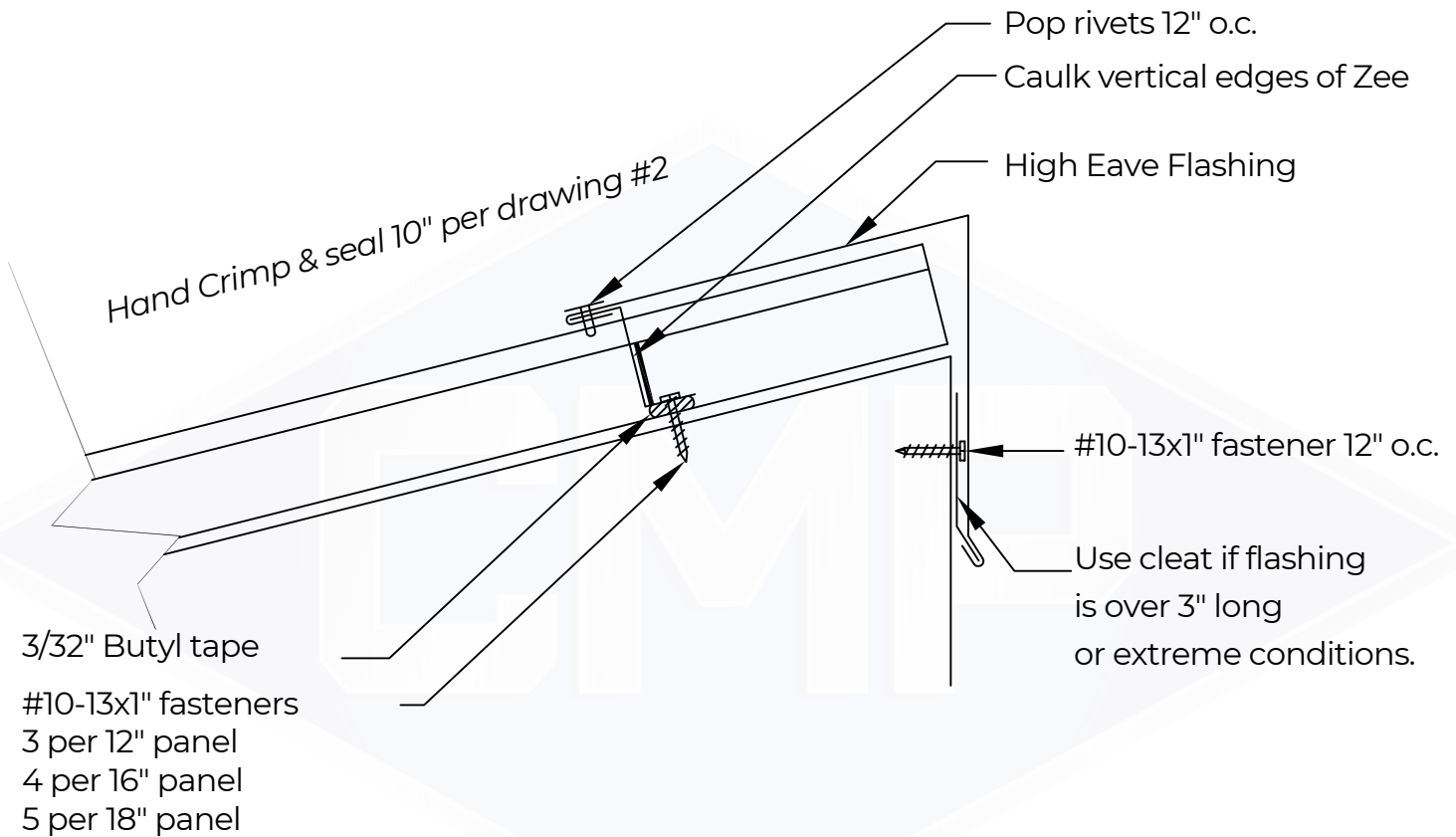

<b>DETAIL: HIGH EAVE FLASHING</b>	<b>CMP</b>	<b>SCALE:</b>
<b>SYSTEM: CMP SERIES 1500</b>		<b>DRAWING NO: 5</b>



# RAKE/GABLE FLASHING

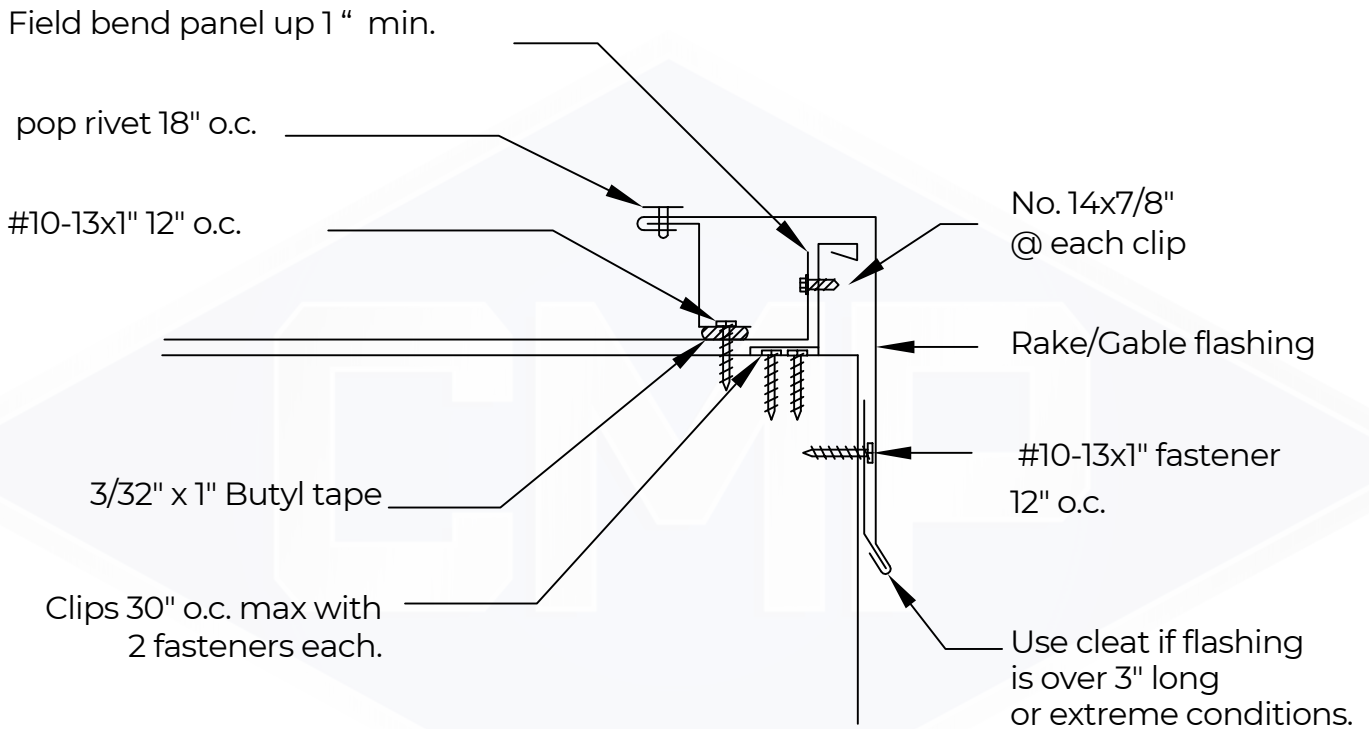

<b>DETAIL: RAKE/GABLE FLASHING</b>	<b>CMP</b>	<b>SCALE:</b>
<b>SYSTEM: CMP SERIES 1500</b>		<b>DRAWING NO: 6</b>





## RIDGE/HIP COVER

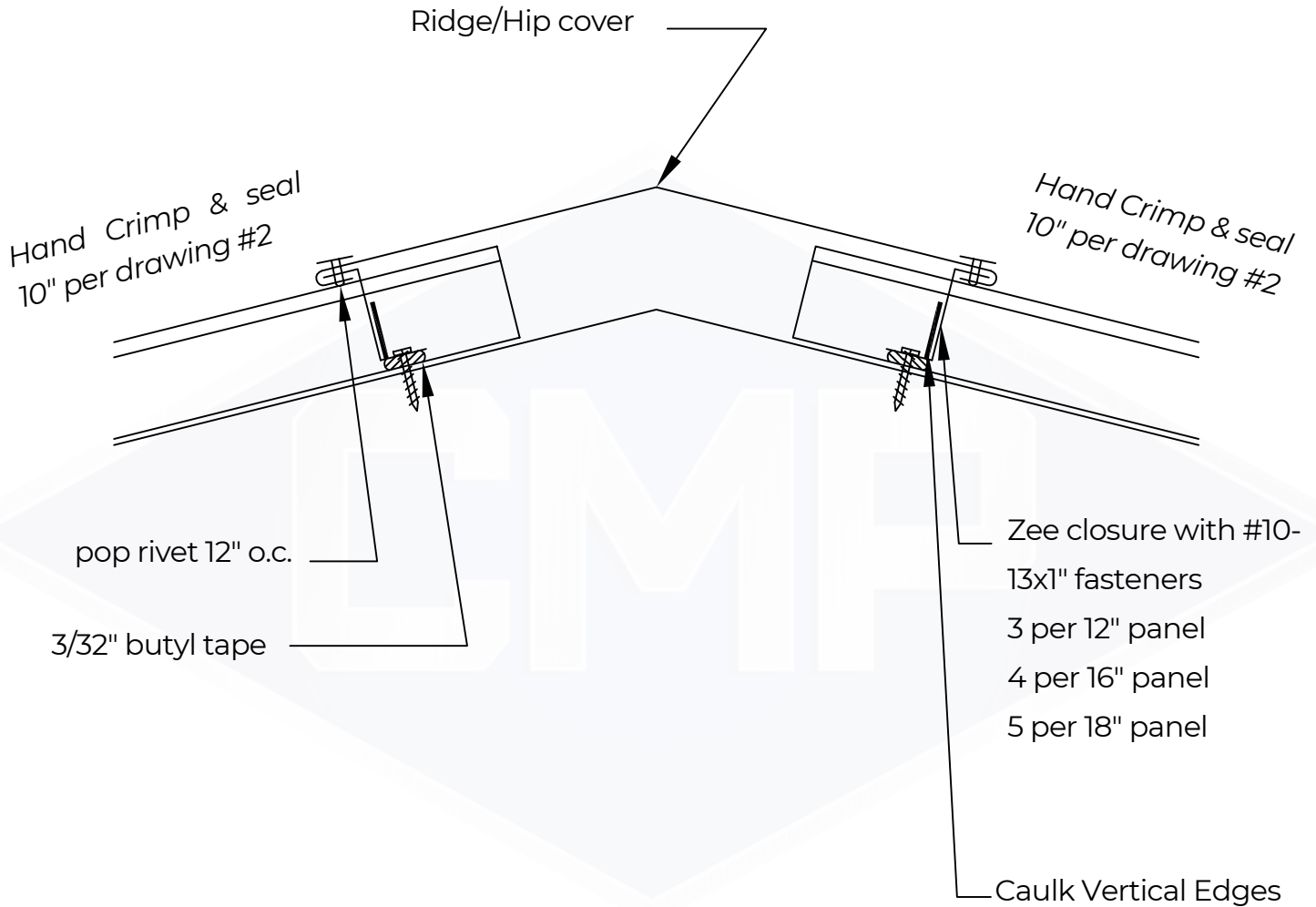

<b>DETAIL: RIDGE/HIP COVER</b>	<b>CMP</b>	<b>SCALE:</b>
<b>SYSTEM: CMP SERIES 1500</b>		<b>DRAWING NO: 7</b>

## VENTED RIDGE

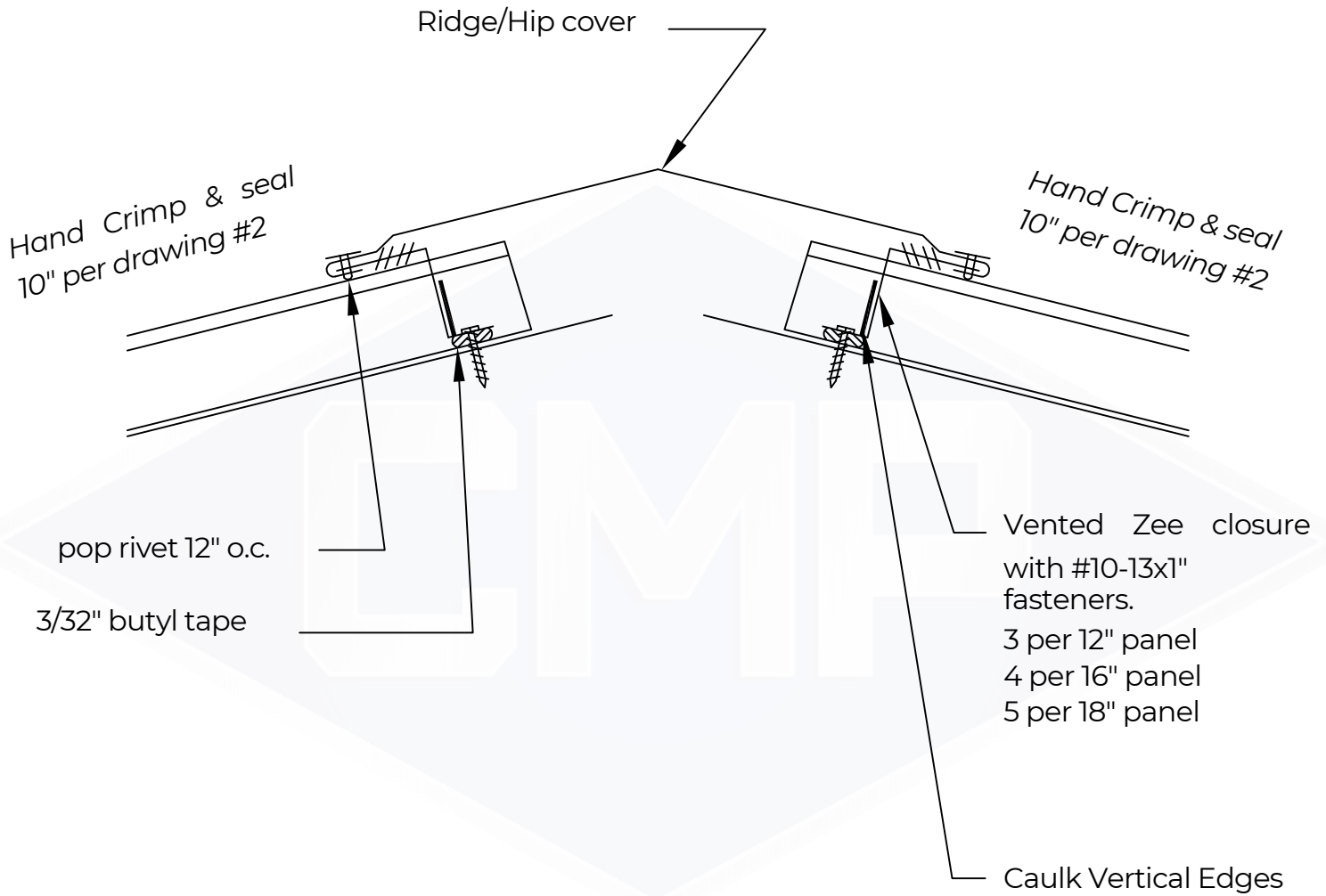

<b>DETAIL: VENTED RIDGE</b>	<b>CMP</b>	<b>SCALE:</b>
<b>SYSTEM: CMP SERIES 1500</b>		<b>DRAWING NO: 8</b>



## VALLEY FLASHING

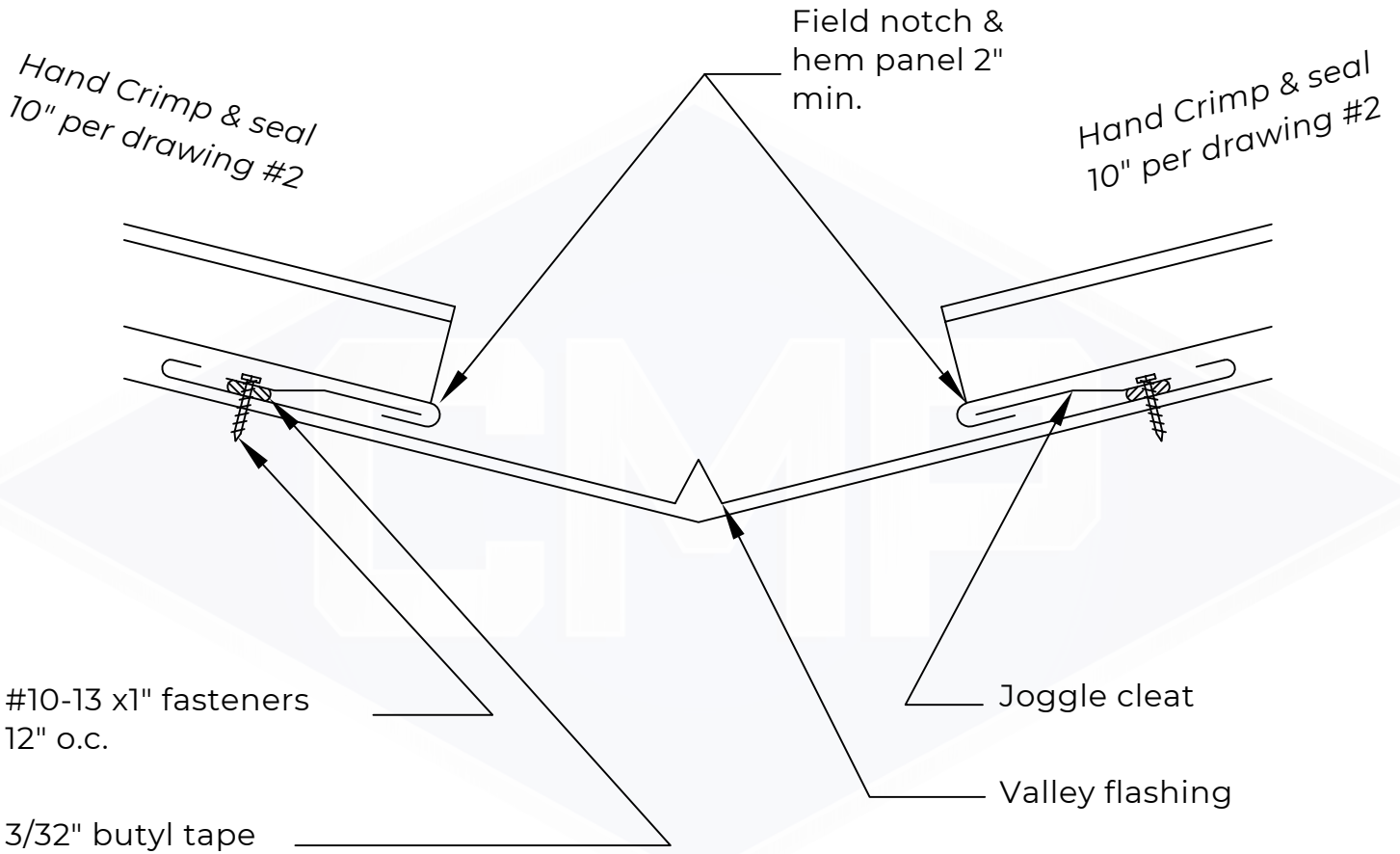

<b>DETAIL: VALLEY FLASHING</b>	<b>CMP</b>	<b>SCALE:</b>
<b>SYSTEM: CMP SERIES 1500</b>		<b>DRAWING NO: 9</b>

## ROOF TO WALL FLASHING

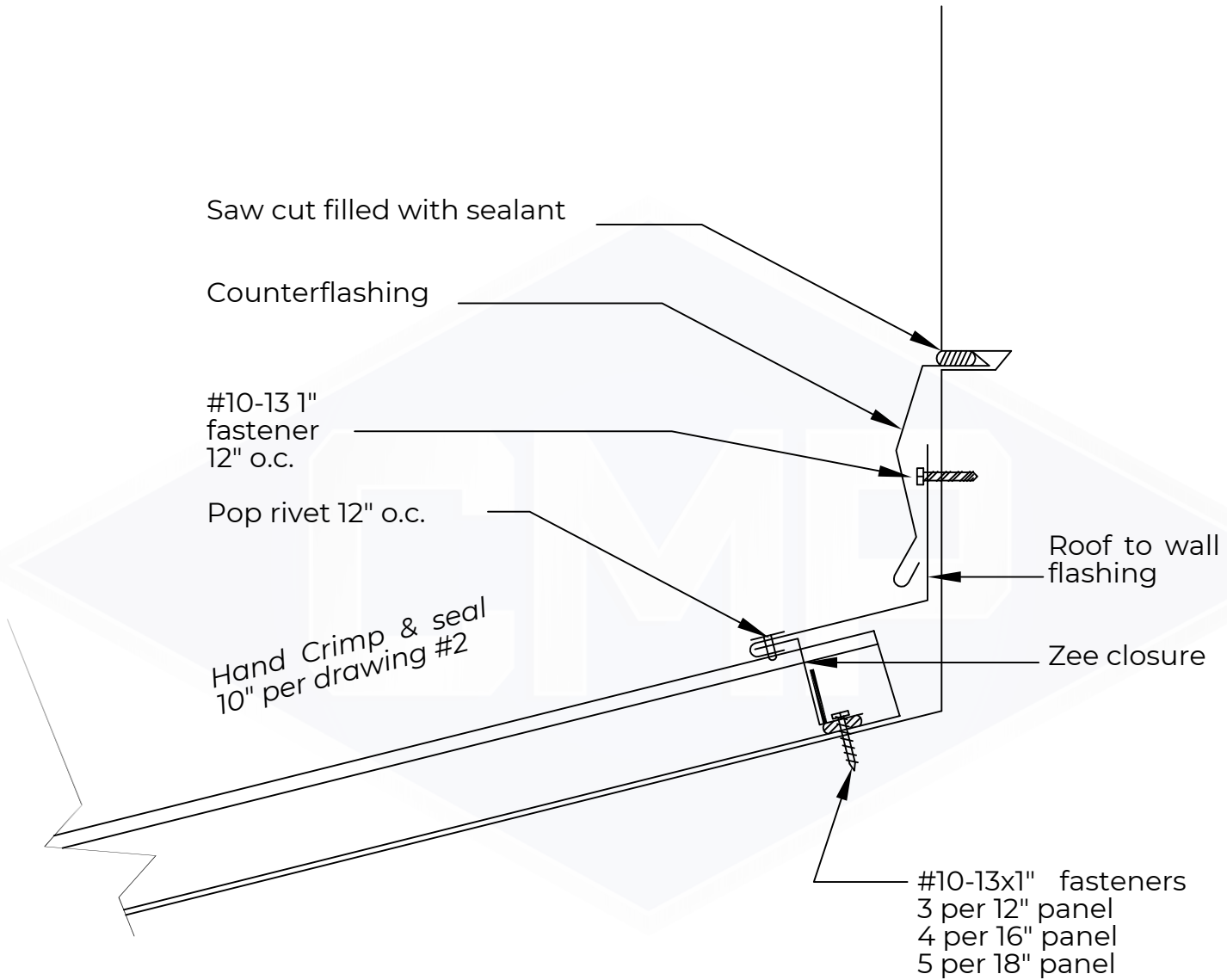

<b>DETAIL: ROOF TO WALL FLASHING</b>	<b>CMP</b>	<b>SCALE:</b>
<b>SYSTEM: CMP SERIES 1500</b>		<b>DRAWING NO: 10</b>



## PITCHBREAK FLASHING

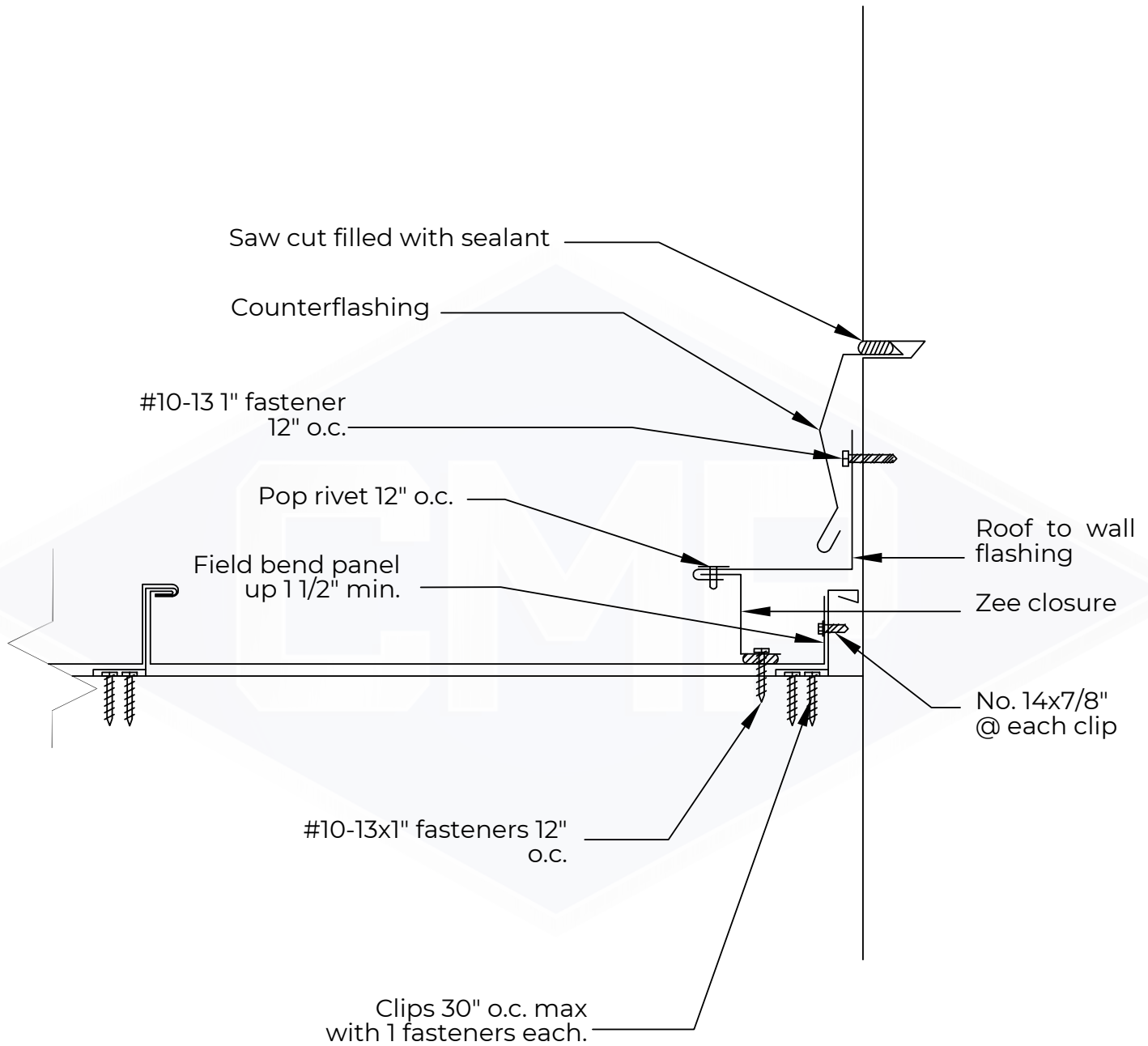

<b>DETAIL: PITCHBREAK FLASHING</b>	<b>CMP</b>	<b>SCALE:</b>
<b>SYSTEM: CMP SERIES 1500</b>		<b>DRAWING NO: 11</b>



## CONSTRUCTION METAL PRODUCTS INC.

Metal Roofing | Metal Walls | Custom Fabrication

### FIND OUT MORE ABOUT CMP



704-871-8704



[questions@cmpmetalsystems.com](mailto:questions@cmpmetalsystems.com)



2204 West Front Street Statesville, NC 28677



[www.cmpmetalsystems.com](http://www.cmpmetalsystems.com)



[www.facebook.com/ConstructionMetalProducts](https://www.facebook.com/ConstructionMetalProducts)