

CMP MULTI RIB TRIM

STEPPED RIDGE

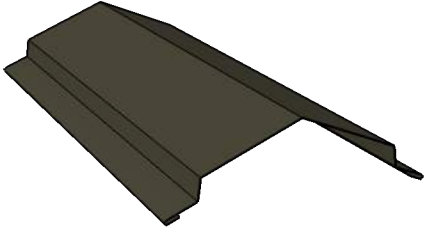

DRIP EDGE

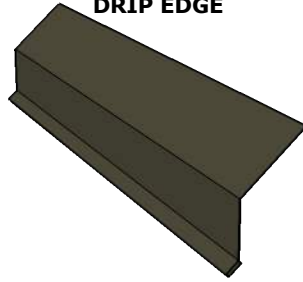

RAKE

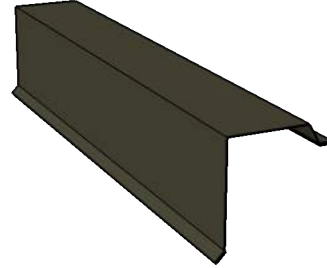

VALLEY

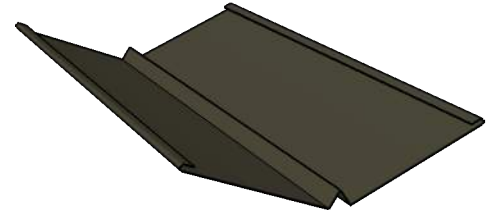

J CHANNEL

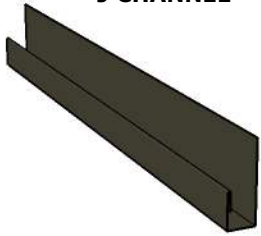

INSIDE CORNER

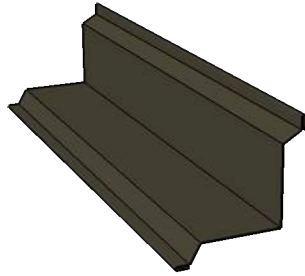

OUTSIDE CORNER

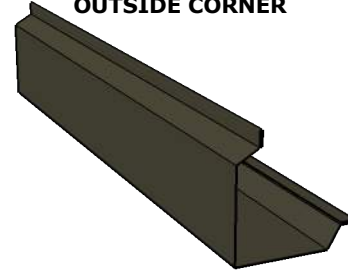

SIDE WALL

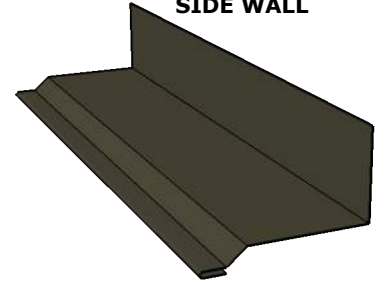

END WALL

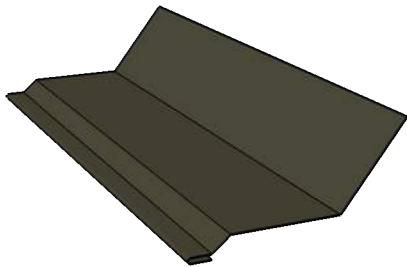

TRANSITION

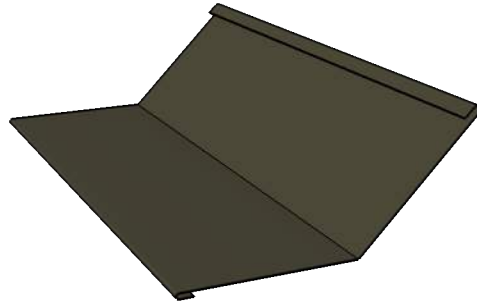

GAMBREL

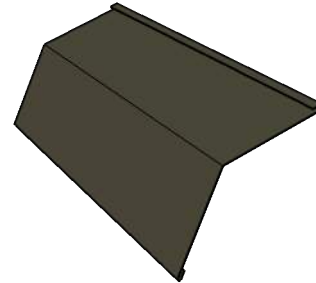

BASE DRIP ANGLE

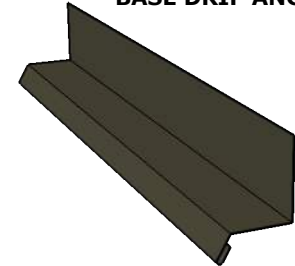

BASE ANGLE STOP

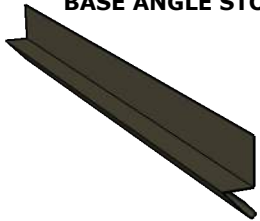

CMP MULTI RIB TRIM

STEPPED RIDGE

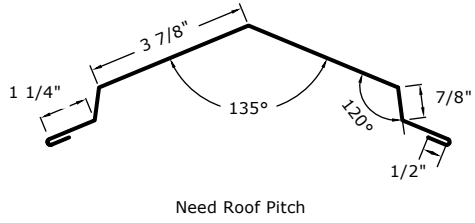

DRIP EDGE

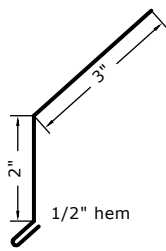

RAKE

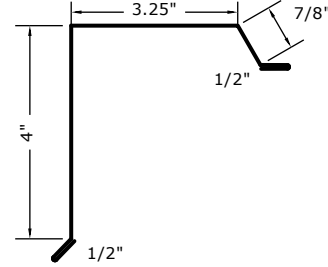

VALLEY

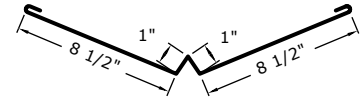

J CHANNEL

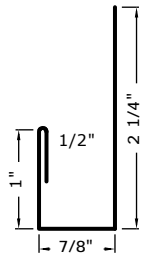

INSIDE CORNER

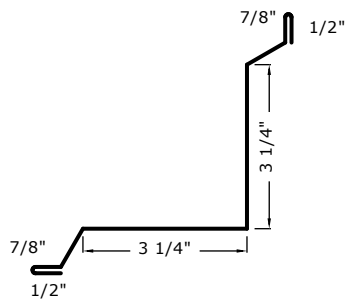

OUTSIDE CORNER

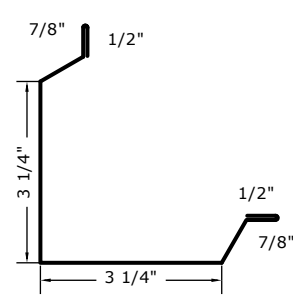

SIDE WALL

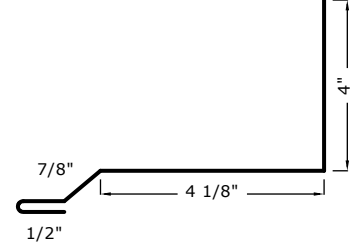

END WALL

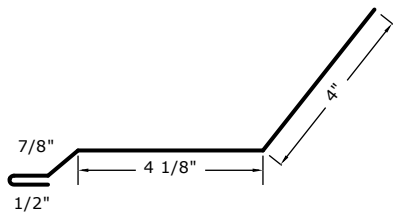

TRANSITION TRIM

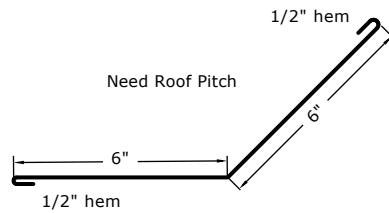

GAMBREL TRIM

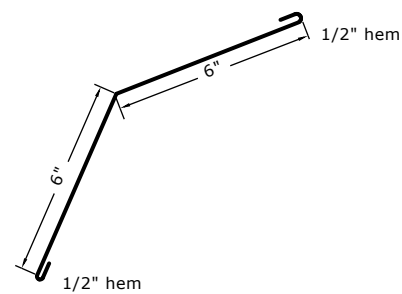

BASE DRIP ANGLE

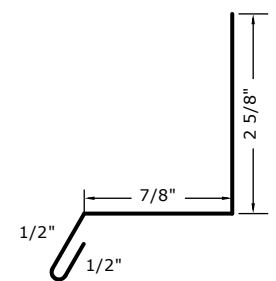

BASE ANGLE STOP

