

# CMP PBR\_R PANEL TRIM

**STEPPED RIDGE**

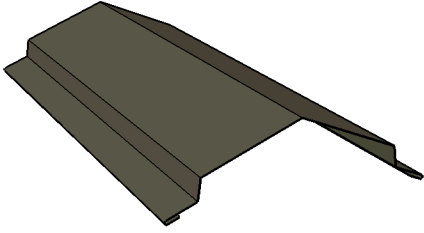

**DRIP EDGE**

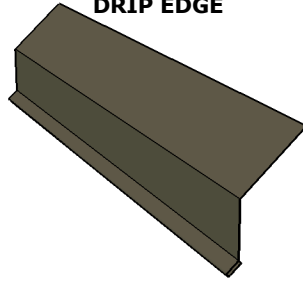

**RAKE**

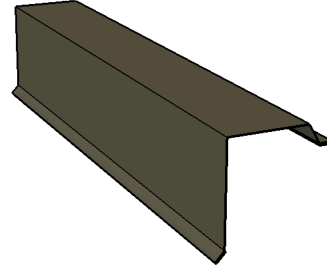

**VALLEY**

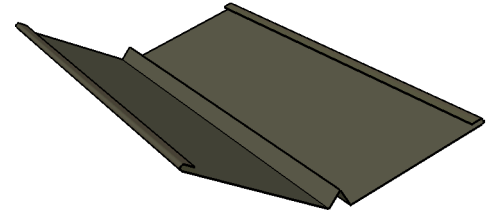

**J CHANNEL**

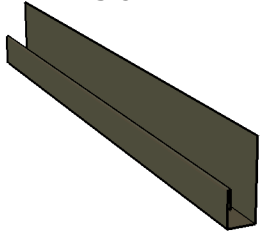

**INSIDE CORNER**

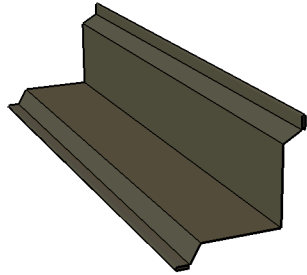

**OUTSIDE CORNER**

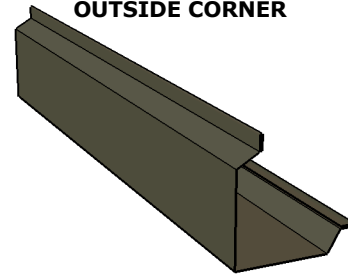

**SIDE WALL**

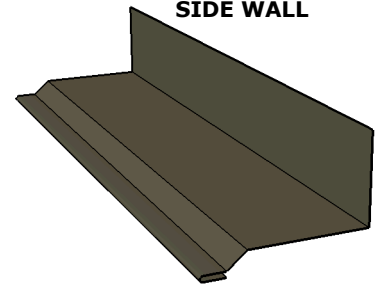

**END WALL**

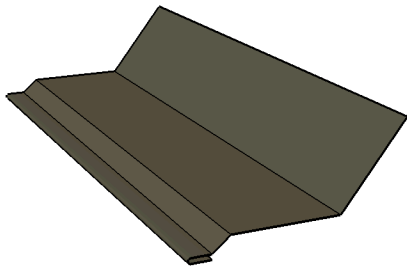

**TRANSITION**

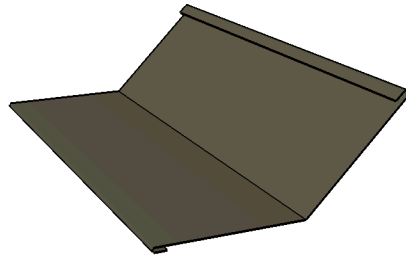

**GAMBREL**

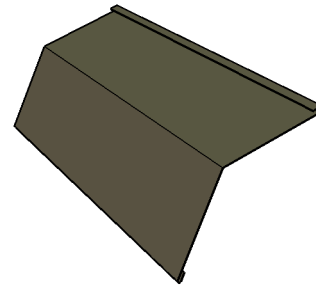

**BASE DRIP ANGLE**

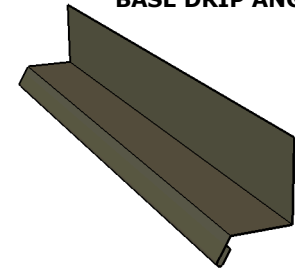

**BASE ANGLE STOP**

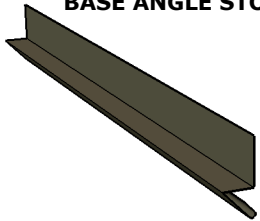

**FORMED RIDGE**



# CMP PBR\_R PANEL TRIM

**STEPPED RIDGE**

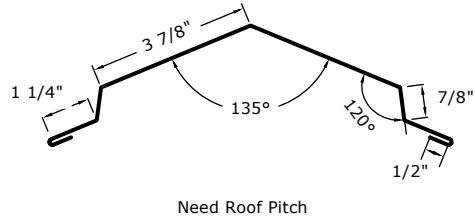

**DRIP EDGE**

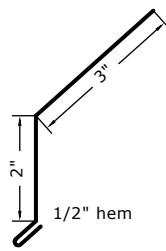

**RAKE**

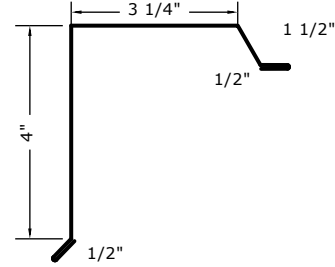

**VALLEY**

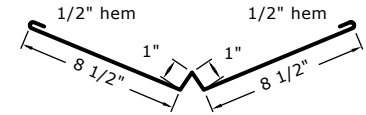

**J CHANNEL**

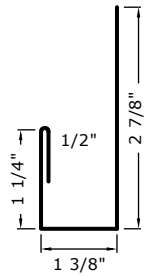

**INSIDE CORNER**

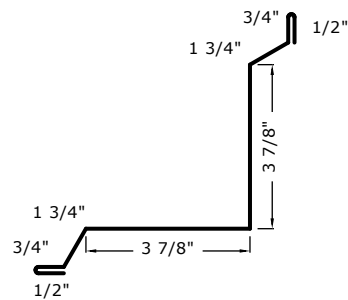

**OUTSIDE CORNER**

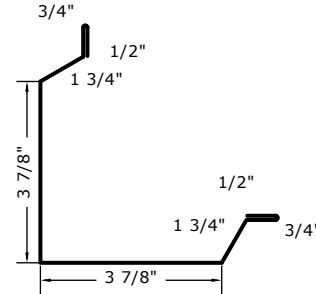

**SIDE WALL**

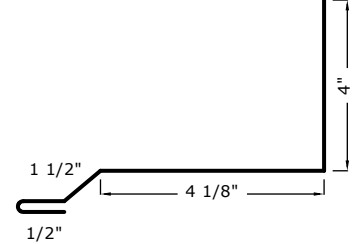

**END WALL**

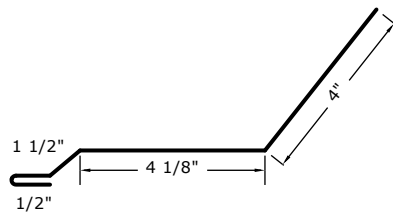

**TRANSITION TRIM**

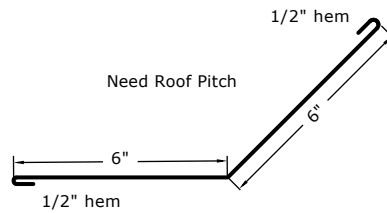

**GAMBREL TRIM**

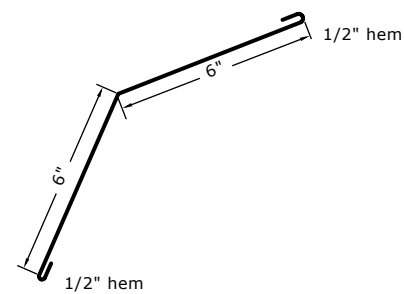

**BASE DRIP ANGLE**

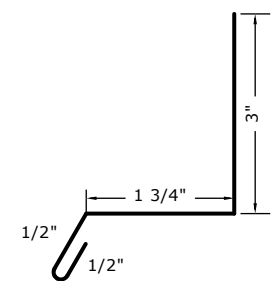

**BASE ANGLE STOP**

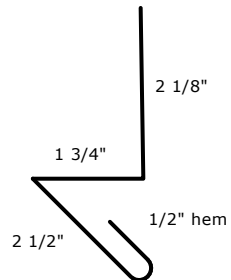

**FORMED RIDGE**

