

# CMP 5V TRIM

**STEPPED RIDGE**

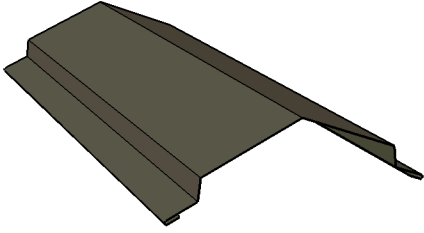

**DRIP EDGE**

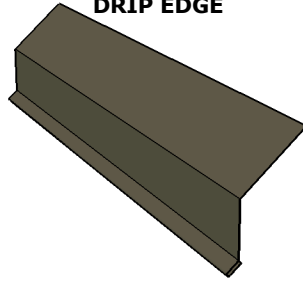

**RAKE**

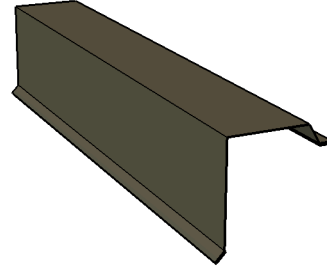

**VALLEY**

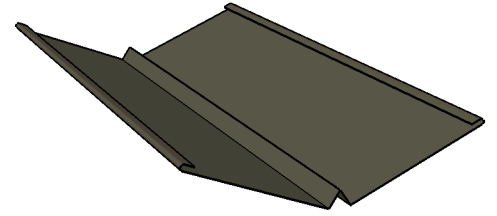

**J CHANNEL**

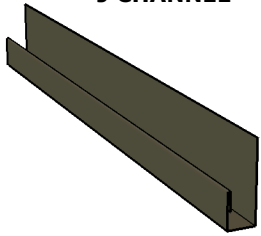

**INSIDE CORNER**

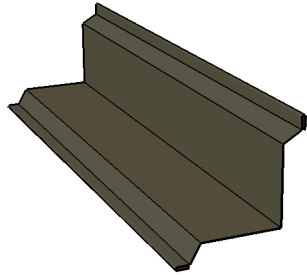

**OUTSIDE CORNER**

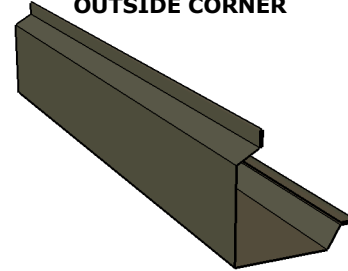

**SIDE WALL**

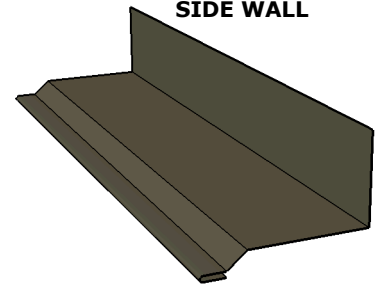

**END WALL**

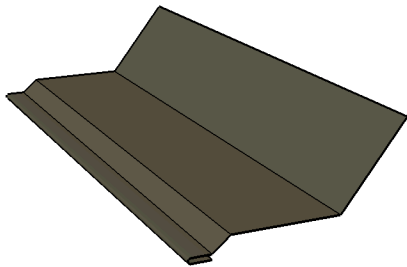

**TRANSITION**

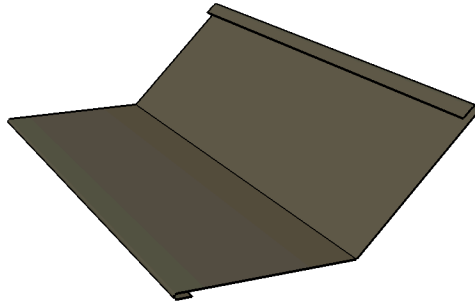

**GAMBREL**

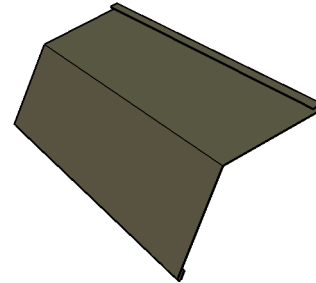

# CMP 5V TRIM

### STEPPED RIDGE

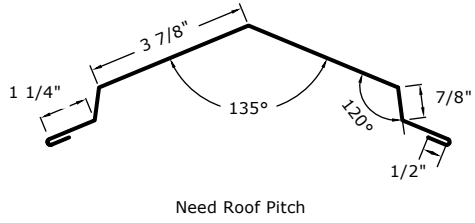

### DRIP EDGE

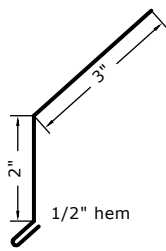

### RAKE

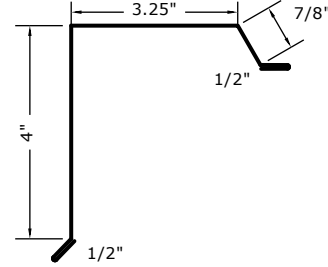

### VALLEY

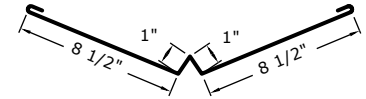

### J CHANNEL

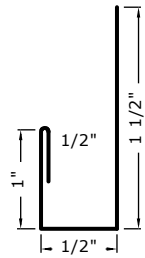

### INSIDE CORNER

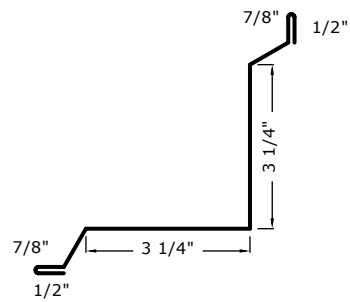

### OUTSIDE CORNER

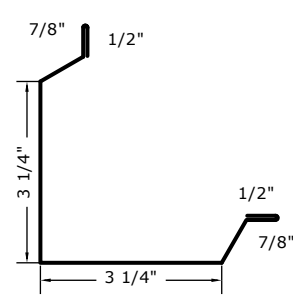

### SIDE WALL

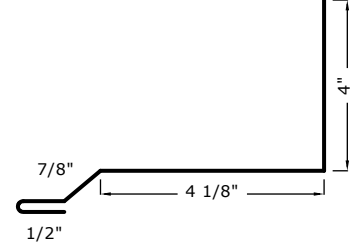

### END WALL

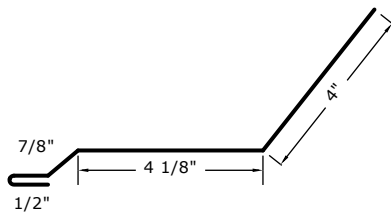

### TRANSITION TRIM

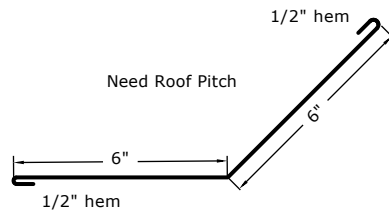

### GAMBREL TRIM

